

## SMART X96-RC MULTIFUNCTION POWER ANALYSER WITH ROGOWSKI COIL



- No need external integrator
- Multi-parameter Measurements
- 3 selectable current scales
- RS485 Modbus RTU
- Accuracy Class 0.5s
- Bar Graph for Power Indication
- Backlit LCD Display for Full Viewing Angles
- Push-in Installation and Plug-in Connection

## Introduction

The multifunction energy analyzer SMART X96-RC is innovative instrument for measurement of electrical parameters. The meters are particularly suitable for consumption analysis and control, with an excellent quality and stability. The meters are directly connected with Rogowski Coil for current measurement, without external integrator. The connections are very quick and easy, very useful for retrofitting applications on existing switchboards or energy audit. The meters are the ideal instrument to establish the measurement points on the plant. Built-in interfaces provide RS485 Modbus RTU.

SMART X96-RC series is a top new-generation intelligent panel meter with , used not only in the electricity transmission and power distribution system, but also in the power consumption measurement and analysis in high voltage intelligent power grid.

This document provides operating, maintenance and installation instructions for the Eastron SMART X96-RC series. The meters measure and display the characteristics of 1p2w, 3p4w and 3p3w supplies, including voltage, frequency, current, power and active and reactive energy, imported or exported, Power factor, Max. Demand etc. Energy is measured in terms of kWh, kVAh and kVAh. Maximum demand current can be measured over preset periods of up to 60 minutes.

The unit uses plug-in terminals for easy wiring and push-in mechanism for quick installation.

## 1. Unit Characteristics

### 1.1 The Unit can measure and display:

- Line Frequency
- Phase Sequence
- Active power, reactive power, apparent power, maximum power demand and power factor
- Max./ Min.Current and voltage, Max.current demand
- Import / export / total active energy
- Import / export / total reactive energy
- Total active energy of each phase
- DPF ( Displacement Power factor, Modbus read only)
- Voltage crest factor (Modbus read only)
- Current K factor (Modbus read only)

### 1.2 The unit has password-protected set-up screens for:

- **Communication setting:** Modbus address, Baud rate, Parity, Stop bit
- **CT setting:** CT 1 ( Max current input)
- **PT setting:** PT1 (Primary), PT2 (Secondary) , PT rate
- **Demand setting:** demand method, Demand interval time
- **Time setting:** Backlit time, display scroll time, system RTC, Tariff Time
- **System configuration:** System type, System connect, Change password, Auto display scroll

### 1.3 CT and PT

CT1 (Max value): 3 selectable scales 1000A/ 5000A / 20000A.

PT1 (primary voltage): 100V ~ 500,000V

PT2 (secondary voltage): 100 to 600 V AC (L-L)

### 1.4 RS485 Serial-Modbus RTU

This unit uses a RS485 serial port with Modbus RTU protocol to provide a means of remote monitoring and controlling.

Please check the Part 4.2 for the details of setting.

## 1.5 Display

Liquid crystal display with backlit (360° full viewing angles)

4 lines, 4 digits per line to show electrical parameters

5<sup>th</sup> line, 8 digits to show energy

Bar graph for power indication

Display update time: 1 sec. for all parameters

Display scrolling: automatic or manual (Programmable)

## 2 . Start up screens

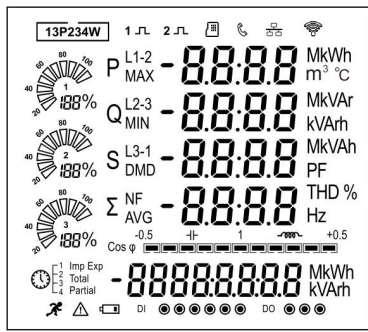

The first screen lights all LED segments and can be used as a display LED check



The second screen indicates the software version of the unit. (the left picture is just for reference)

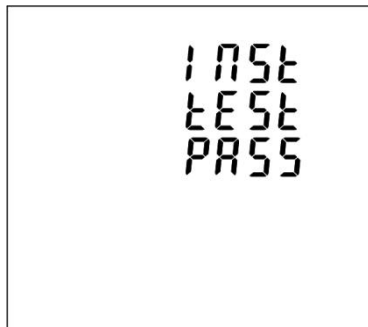





The unit performs a self-test and the screen indicates if the test is passed.



After a short delay, the default measurement screen appears.



## 3 . Buttons and Displays

### 3.1 Buttons Function

Buttons	Click	Press 2S
	<ul style="list-style-type: none"> <li>&gt; Displays power, voltage, current and energy information of each phase</li> <li>&gt; Exit from the menu</li> </ul>	<ul style="list-style-type: none"> <li>&gt; Automatic Scroll display ON / OFF</li> </ul>
	<ul style="list-style-type: none"> <li>&gt; Display Voltage and current information of the selected system type. (3p4w, 3p3w and 1p2w)</li> <li>&gt; Phase sequence</li> <li>&gt; Left side move</li> </ul>	
	<ul style="list-style-type: none"> <li>&gt; Display power factor, frequency, Max. Demand.</li> <li>&gt; Max. and Min. of current and voltage</li> <li>&gt; Up page or add value</li> </ul>	
	<ul style="list-style-type: none"> <li>&gt; Display active power, reactive power and apparent power information of the selected system type.</li> <li>&gt; Down page or reduce value</li> </ul>	<ul style="list-style-type: none"> <li>&gt; Running hour</li> <li>&gt; Full Screen checking</li> <li>&gt; Modbus / Ethernet setting information</li> </ul>
	<ul style="list-style-type: none"> <li>&gt; Display total / import / export active or reactive energy information of the selected system type.</li> <li>&gt; Right side move</li> </ul>	<ul style="list-style-type: none"> <li>&gt; Set-up mode entry</li> <li>&gt; Confirmation</li> </ul>

### 3.2 Display Mode Screen Sequence

Click button	3 Phase 4 Wire		3 Phase 3 Wire		1 Phase 2 Wire	
	Screen	Parameters	Screen	Parameters	Screen	Parameters
	1	Phase 1 – Power Voltage Current kWh	1	Phase 1 – Power Voltage Current kWh	1	Phase 1 – Power Voltage Current kWh
	2	Phase 2 – Power Voltage Current kWh	2	Phase 2 – Power Voltage Current kWh		
	3	Phase 3 – Power Voltage Current kWh	3	Phase 3 – Power Voltage Current kWh		
	4	Phase 1 – Power Voltage Current kVarh	4	Phase 1 – Power Voltage Current kVarh	2	Phase 1 – Power Voltage Current kVarh
	5	Phase 2 – Power Voltage Current kVarh	5	Phase 2 – Power Voltage Current kVarh		
	6	Phase 3 – Power Voltage Current kVarh	6	Phase 3 – Power Voltage Current kVarh		
	1	Voltage L1-N Voltage L2-N Voltage L3-N			1	Voltage L1-N
	2	Voltage L1-L2 Voltage L2-L3 Voltage L3-L1	1	Voltage L1-L2 Voltage L2-L3 Voltage L3-L1		
	3	Current L1 Current L2 Current L3 Current Neutral	2	Current L1 Current L2 Current L3	2	Current L1
	4	Phase Sequence	3	Phase Sequence		
	1	Total Power Factor Frequency	1	Total Power Factor Frequency	1	Total Power Factor Frequency
	2	PF L1 PF L2 PF L3	2	PF L1 PF L2 PF L3		

	3	Max. DMD of Current L1 Max. DMD of Current L2 Max. DMD of Current L3	3	Max. DMD of Current L1 Max. DMD of Current L2 Max. DMD of Current L3	2	Max. DMD of Current L1
	4	Max. DMD of W Max. DMD of Var Max. DMD of VA	4	Max. DMD of W Max. DMD of Var Max. DMD of VA	3	L1 Max. DMD of W L1 Max. DMD of Var L1 Max. DMD of VA
	5	Max. Voltage L1-N Max. Voltage L2-N Max. Voltage L3-N	5	Max. Voltage L1-L2 Max. Voltage L2-L3 Max. Voltage L3-L1	4.	Max. Voltage L1-N
	6	Min. Voltage L1-N Min. Voltage L2-N Min. Voltage L3-N	6	Min. Voltage L1-L2 Min. Voltage L2-L3 Min. Voltage L3-L1	5.	Min. Voltage L1-N
	7	Max. Current L1 Max. Current L2 Max. Current L3 Max.Current Neutral	7	Max. Current L1 Max. Current L2 Max. Current L3	6	Max. Current L1
	8	Min. Current L1 Min. Current L2 Min. Current L3 Min.Current Neutral	8	Min. Current L1 Min. Current L2 Min. Current L3	7	Min. Current L1
	1	Active Power L1 Active Power L2 Active Power L3	1	Active Power L1 Active Power L2 Active Power L3		
	2	Reactive Power L1 Reactive Power L2 Reactive Power L3	2	Reactive Power L1 Reactive Power L2 Reactive Power L3		
	3	Apparent Power L1 Apparent Power L2 Apparent Power L3	3	Apparent Power L1 Apparent Power L2 Apparent Power L3		
	4	Total Active Power Total Reactive Power Total Apparent Power	4	Total Active Power Total Reactive Power Total Apparent Power	1	L1 Active Power L1 Reactive Power L1 Apparent Power
	1	Total kWh	1	Total kWh	1	Total kWh
	2	Total kVarh	2	Total kVarh	2	Total kVarh
	3	Import kWh	3	Import kWh	3	Import kWh
	4	Export kWh	4	Export kWh	4	Export kWh
	5	Import kVarh	5	Import kVarh	5	Import kVarh
	6	Export KVarh	6	Export KVarh	6	Export KVarh





### 4.1 Password Entry

<p>The LCD display shows the word 'PASS' in the top line and the number '1000' in the bottom line. The '1' in '1000' is red.</p>	<p>Setting-up mode is password protected, so you must enter the correct password. By firmly press the button  for 2 seconds, the password screen appears. The default password is 1000. If an incorrect password is entered, the display shows ERR.</p>
--	--

### 4.2 Communication







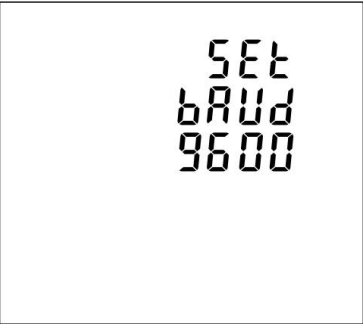

<p>The LCD display shows the word 'SET' in the top line, '75' in the second line, '485' in the third line, and 'COMM' in the bottom line.</p>	<p>The RS485 port can be used for communications using Modbus RTU protocol. Parameters such as Address, Baud rate, Parity, Stop bit can be selected. Long press  to enter the Address option.</p>
---	--

#### 4.2.1 Address









<p>The LCD display shows the word 'SET' in the top line, 'Addr' in the second line, and '001' in the bottom line.</p>	<p>An RS485 network can accommodate up to 255 different devices, each identified by an address. Modbus address range 001~247 Default 001</p> <p>Long press  to enter the selection routine, the address setting will flash. Use  and ,  to set the address with the range 001~247. And press  for confirmation.</p>
---	--

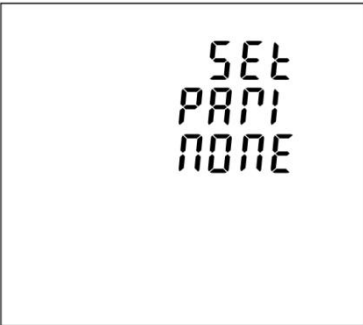

#### 4.2.2 Baud rate











	<p>Baud rate options: 2400 4800 9600 19200 38400 (bps). Default: 9600bps</p> <p>From the Set-up menu, Use  and  to select the Baud rate options.</p> <p>Long press  to enter the selection routine. The Baud Rate setting will flash.</p> <p>Use  and  to choose Baud Rate.</p>
	<p>Example shows: SET Baud rate 19200 (bps)</p> <p>And long press  for confirmation.</p>

### 4.2.3 Parity

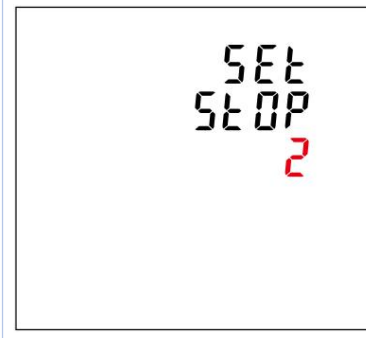

	<p>Parity Options: NONE, EVEN, ODD. Default Parity : NONE</p> <p>Note that if parity is set to ODD or EVEN, Stop Bits will be set to 1 and cannot be changed.</p> <p>From the Set-up menu, Use  and  to select the Parity options.</p> <p>Long press  to enter the selection routine. The Parity setting will flash. Use  and  to choose Parity.</p>
	<p>Example shows: Set Parity: EVEN</p> <p>And long press  for confirmation. Press  to return the main set up menu.</p>

	<p>Example shows: Set Parity: Odd</p> <p>And long press  for confirmation. Press  to return the main set up menu.</p>
---	---

### 4.2.4 Stop bit

	<p>Stop Bit options: 1 or 2. Default Stop Bit : 1 Note that if parity is set to ODD or EVEN, Stop Bits will be set to 1 and cannot be changed.</p> <p>From the Set-up menu, Use  and  to select the Stop Bit options.</p> <p>Long press  to enter the Stop Bit routine. The Stop Bit setting will flash. Use  and  to choose Stop Bit.</p>
	<p>Example shows Set Stop bit 2</p> <p>And long press  for confirmation. Press  to return the Communication set up menu.</p>

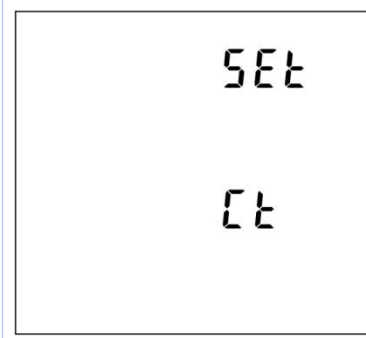
### 4.3 CT

	<p>From the main Set-up menu, Use  and  to select the CT option.</p>
---	--



### 4.3.1 CT1

	<p>Set current input the meter Options: 1kA,5kA,20kA Default CT2: 1kA</p> <p>Long press  to enter the CT1 routine. Press  for 2s, the CT1 setting will flash. Use  and  to choose CT1 with 1kA,5kA or 20kA.</p>
	<p>Example shows : Set CT1 5kA</p> <p>And long press  for confirmation.</p>





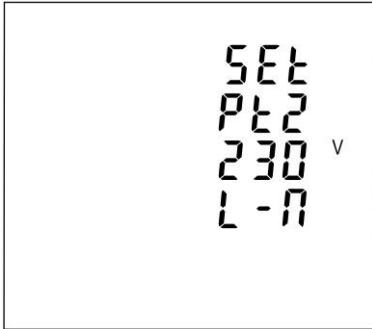

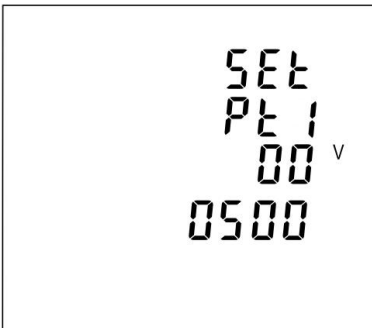

### 4.4 PT

	<p>The PT option sets the secondary voltage of the voltage transformer (PT) that give into the meter and the PT rate between the primary voltage to the secondary voltage.</p> <p>For example: if the PT connect to the meter is 10000/100V (Primary voltage is 10000V, secondary voltage is 100V), then the PT rate is 100.</p> <p>Long press  to enter the PT2 routine. Press , the PT2 setting will flash.</p> <p>Use  and ,  to choose PT2 with 174~480.</p>
--	--



#### 4.4.1 PT2

	<p>Set secondary voltage input the meter Range: 100V ~ 480V Default: 230V</p> <p>And long press  for confirmation.</p>
---	---

#### 4.4.2 PT1

	<p>Set primary voltage input the meter Range: 100V ~ 500000V Default: 230V</p> <p>Then press  to enter the PT2 routine. press  for 2s, the PT2 setting will flash. Use  and  ,  to select PT2. And long press  for confirmation. Press  to return the PT set up menu.</p>
--	--

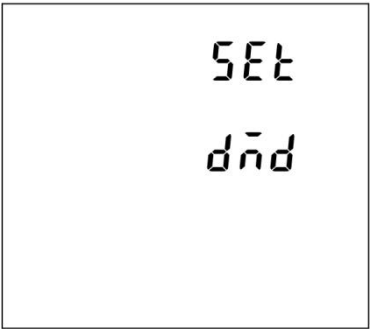
#### 4.5 Demand

	<p>This sets the period in minutes over which the current and power readings are integrated for maximum demand measurement. The options are: OFF, 5, 8, 10, 15,30, 60 minutes.</p> <p>From the Set-up menu, Use  and  to select the Demand option.</p>
---	---

The unit provides block interval demand calculation. In this method, you select a 'block' of time that power meter uses for the demand calculation. You choose how the power meter handles that block of time (interval). Two different modes are optional.

**Slide Block:** Select a demand interval time (DIT) from 1 to 60 minutes (in 1 minute increments). Set the calculation update time from 1 to 59minutes. The power meter displays the demand value for the last completed interval.

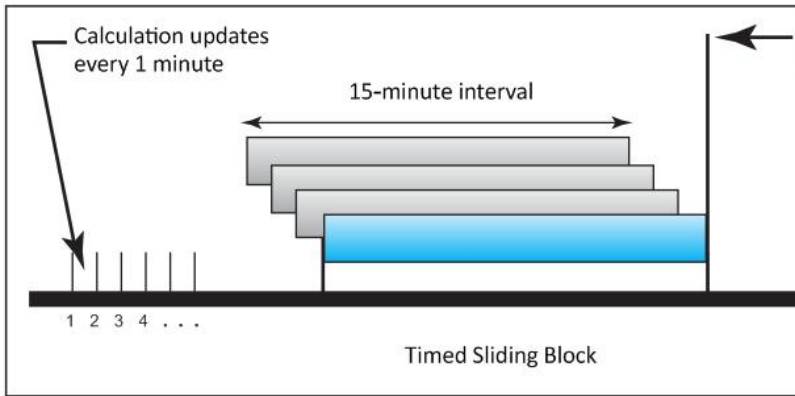



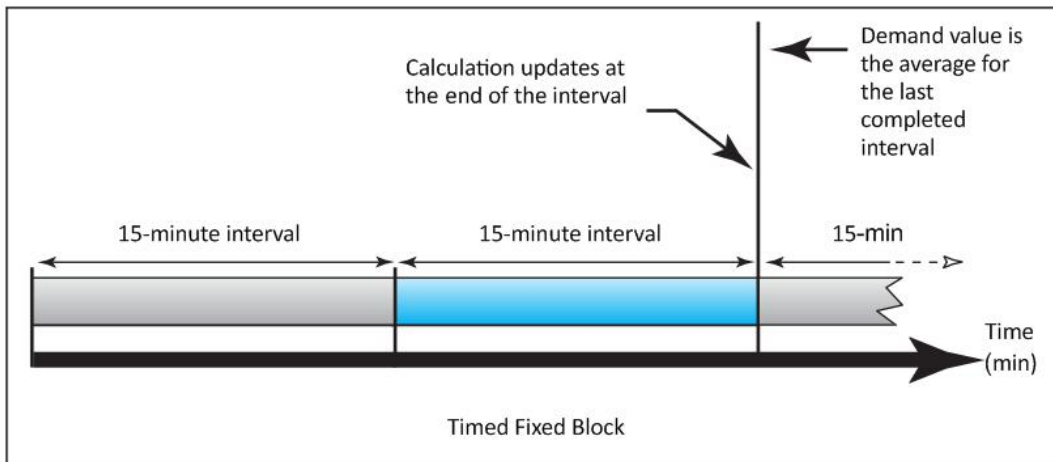



**Fixed Block:** Select an interval from 1 to 60 minutes (in 1 minute increments). The power meter calculates an updates the demand at the end of each interval.

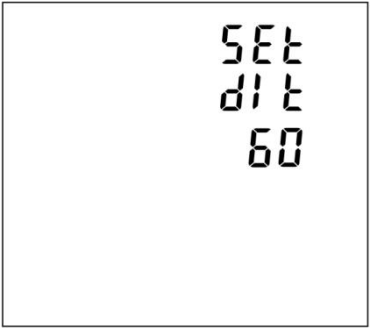

### 4.5.1 Demand method

	<p>The screen shows the Demand calculation method: Slid Options: Fix and Slid</p> <p>Use  and  to enter Demand calculation method.</p>
	<p>Long press  to enter the routine. The setting will flash. Use  and  to choose Options. And long press  for confirmation. Press  to return the Demand set up menu.</p>



### 4.5.2 Demand interval time/ Block time (DIT)

	<p>The screen will show the currently selected integration time. Default is 60 minutes. range from 1 to 60. Off means function closed.</p> <p>Long press  to enter the DIT routine. Press  for 2s, the setting will flash. Use  and  to choose Options. And long press  for confirmation.</p>
---	--

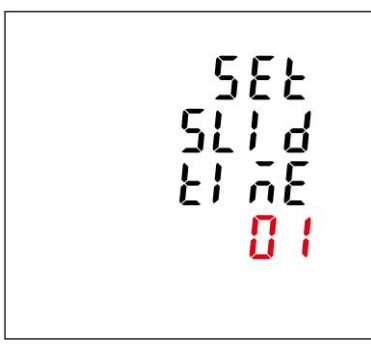
### 4.5.3 Sliding time

	<p>The screen will show the Sliding time for the sliding mode.</p> <p>The sliding time shall be set not bigger than the DIT.</p>
--	--

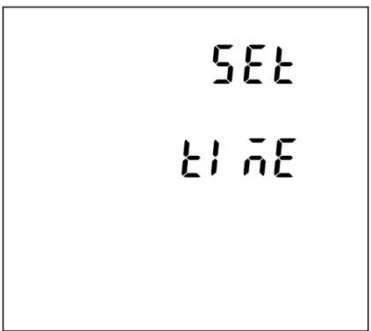
### 4.6 Time

	<p>This option sets the backlight lasting time and display scroll time.</p> <p>From the Set-up menu, Use  and  to select the Time option.</p>
---	--

### 4.6.1 Backlight time

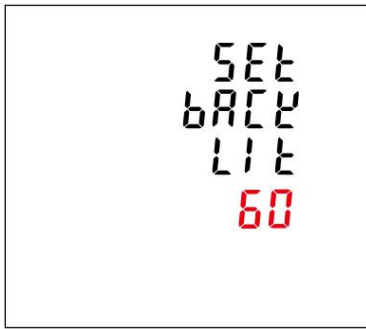





The meter provides a function to set the backlit lasting time.

Options: ON/OFF/5/10/30/60/120 minutes. Default: 60

If it is seated as 5, the backlit will be off in 5 minutes.

Note: if it is set as ON, the backlit will always be on.

Long press  to enter the Backlit time routine. Press  for 2s, the setting will flash. Use  and  to choose Options. And long press  for confirmation.

### 4.6.2 Display scroll time

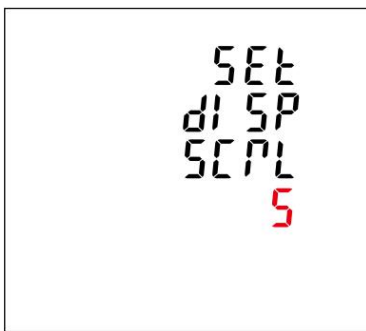







The meter provides a function to set the Display scroll time.







Options: 1~255s

Default: 5

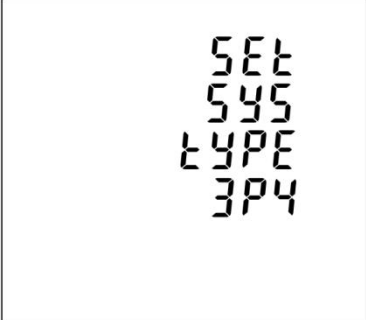
If it is seated as 5, the display will scroll every 5s.

Use  and  to select Display scroll time option. Press  for 2s, the setting will flash. Use  and  to choose Options. And Long press  for confirmation. Press  to return the Time set up menu.

### 4.7.1 System type

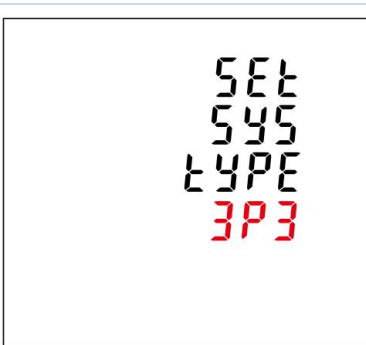
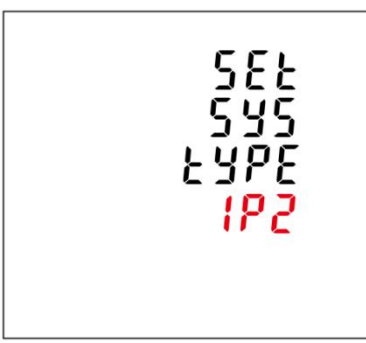
	<p>The screen shows the currently selected power supply is three phase four wire</p> <p>Long press  to enter the System type routine. Press  for 2s, the setting will flash. Use  and  to choose Options. And Long press  for confirmation.</p>
	<p>Example shows: The screen shows the currently selected power supply is three phase three wire</p>
	<p>Example shows: The screen shows the currently selected power supply is single phase two wire</p>



**4.7.2 System connect**



	<p>This unit provides a function with Reverse connected current inputs correction setting.</p> <p>Use  and  to select the correction option.</p>
	<p>Options: Frd ( forward ) and rEv ( reverse) The default is FRD ( forward )</p> <p>Long press  to enter the Phase 1 correction. Press  for 2s, the setting will flash. Use  and  to choose Options. And long press  for confirmation.</p>
	<p>Press  enter Phase 2 correction. Press  for 2s, the setting will flash. Use  and  to choose Options. And long press  for confirmation.</p>
	<p>Press  enter Phase 3 correction. Press  for 2s, the setting will flash. Use  and  to choose Options. And long press  for confirmation. Press  to return the System set up menu.</p>

### 4.7.3 Change password



	<p>This unit provides a function with password setting. Default: 1000 Options:0000~99999</p> <p>Use  and  to select the change password option.</p>
	<p>Press  for 2s, the setting will flash. Use  and ,  to choose Options. And long press  for confirmation.</p>

### 4.7.4 Automatic display scroll

	<p>This unit provides a function with automatic display scroll setting. Options: on and off There are two ways:</p> <p>① Use  and  to select the automatic display scroll option. Press  for 2s, the setting will flash. Use  and  to choose options "On" or "Off". And long press  for confirmation.</p>
--	---

	<p>② Escape the Setting menu. Long press  for 2 secs. For example, the screen shows the currently selected Automatic Scroll display ON.</p>
	<p>Long press  for 2 secs, then the screen shows the currently selected Automatic Scroll display OFF.</p>

#### 4.12 Reset

	<p>This unit provides a function with reset for different information.</p> <p>By pressing the button , the user can get into sub-menu.</p> <p>Use  and  to select the Reset option.</p>
	<p>This option is to reset Energy information. It would reset active, reactive, apparent, import, export energy information.</p>



PE-  
SET  
  
dnd

This option is to reset the demand information.  
It would reset current and power demand information.

## 5. Specifications

Table 1

Electrical characteristics		
Type of measurement		RMS including harmonics on three phase AC system (3P, 3P+N) 128 samples per cycle
Measurement accuracy	Power	IEC 61557-12 Class 0.5
	Active Energy	IEC 62053-22 Class 0.5S, IEC 61557-12 Class 0.5
	Reactive Energy	IEC62053-23 Class 2, IEC 61557-12 Class 2
	Frequency	±0.1%
	Current	±0.2%
	Voltage	±0.2%
	Power Factor	±0.01
Harmonic Distortion		2
Data Update Rate		1 second nominal
Input-Voltage	VT Primary	100~500000V ac
	Un	230 V L-N
	Measured Voltage with Over-range and Crest Factor	100 to 480Vac L-L 100 to 276Vac L-N
	Permanent Overload	490V L-L 280V L-N
	Impedance	1M Ω
	Frequency Range	45~66Hz
Input- Current	Max current input	3 selectable current scales: 1000A,5000A, 20000A
	Withstand	0.1% I <sub>max</sub>
	Impedance	< 1 m Ω
	Frequency Range	45~66Hz
Auxiliary Power Supply	Operating Range	65~480V AC / 80~660V DC
	Power Consumption	< 7VA/3.5W.
	Frequency	45 to 65 Hz
Mechanical Characteristics		
Weight		450g
IP Degree of Protection (IEC 60529)		IP51 front display
Dimensions (WxHxD)		96x96x70.3
Mounting Position		Vertical
Panel Thickness		1~5mm
Material of meter case		Self-extinguishing UL 94 V-0
Mechanical environment		M1
Environmental Characteristics		
Operating Temperature		-25 to 55°C
Storage Temperature		-40 to 70°C
Humidity Rating		<95% RH at 50 °C (non-condensing)
Pollution Degree		2
Altitude		2000m
Vibration		10Hz to 50Hz, IEC 60068-2-6
Electromagnetic Compatibility		
Electrostatic Discharge		IEC 61000-4-2
Immunity to Radiated Fields		IEC 61000-4-3
Immunity to Fast Transients		IEC 61000-4-4

Immunity to Impulse Waves	IEC 61000-4-5
Conducted Immunity	IEC 61000-4-6
Immunity to Magnetic Fields	IEC 61000-4-8
Immunity to Voltage Dips	IEC 61000-4-11
Radiated Emissions	EN55011 Class A
Conducted Emissions	EN55011 Class A
Harmonics	IEC 61000-3-2
<b>Safety</b>	
Measurement Category	Per IEC61010-1 CAT III
Current Inputs	Require external Current Transformer for Insulation
Over voltage Category	CAT III
Dielectric Withstand	As per IEC 61010-1 Double Insulated front panel display
Protective Class	II
<b>Communications</b>	
Interface standard and protocol	RS485 and MODBUS RTU
Communication address	1~247
Transmission mode	Half duplex
Data type	Floating point
Transmission distance	1000m Maximum
Transmission speed	2400bps~38400bps
Parity	None (default), Odd, Even
Stop bits	1 or 2
Response time	<100 mS

Table 2

Features	X96-3RC
<b>Instantaneous Measurements</b>	
Current	●
Voltage L-N	●
L-L	●
Frequency	●
Active power	●
Reactive power	●
Apparent power	●
Power factor	●
<b>Energy Values</b>	
Active energy	●
Reactive energy	●
Apparent energy	●
<b>Demand Values</b>	
Current	●
Active, reactive, apparent power	●
<b>Maximum Demand Values</b>	
Maximum current	●
Maximum active power	●
Maximum reactive power	●
Maximum apparent power	●
<b>Min. and Max. Value</b>	
Active power per phase and total	●
Reactive power per phase and total	●
Apparent power per phase and total	●
PF per phase and total	●
Current per phase and average	●
<b>Power-Quality Values</b>	
Total harmonic distortion	●
Running Hour	●
Real Time Clock	●
<b>Network</b>	
Single phase 2 wire	●
Two phase 3 wire	●
Three phase 3 wire	●
Three phase 4 wire	●
CT programmable	●
PT programmable	●
<b>Inputs and Outputs</b>	
Digital Inputs	—
Digital Outputs	—
Alarms	—

Communications	
RS485	●
M-Bus	*
Lora	*
Accuracy	
Active energy	Cl. 0.5s
Reactive energy	1%
Current	0.5%
Voltage	0.5%
Power	0.5%
Hz	0.2%
Number of measurement points per circle	128
Auxiliary power supply	●

Note: ● = included

\* = optional

— = excluded

## 6. Maintenance

In normal use, little maintenance is needed. As appropriate for service conditions, isolate electrical power, inspect the unit and remove any dust or other foreign material present. Periodically check all connections for freedom from corrosion and screw tightness, particularly if vibration is present.

The front of the case should be wiped with a dry cloth only. Use minimal pressure, especially over the viewing window area. If necessary wipe the rear case with a dry cloth. If a cleaning agent is necessary, isopropyl alcohol is the only recommended agent and should be used sparingly. Water should not be used. If the rear case exterior or terminals should be contaminated accidentally with water, the unit must be thoroughly dried before further use. Should it be suspected that water might have entered the unit, factory inspection and refurbishment is recommended.

In the unlikely event of a repair being necessary, it is recommended that the unit be returned to the factory or nearest Eastron distributor.

## Battery Replacement

The meter provides multi tariffs and RTC, it has a 3V DC battery as backup power supply. When the battery voltage is lower than 2.4V DC, the meter LCD will shows warning symbol . The user needs to replace the battery with a new one.



**When you replace the battery, make sure the meter's voltage input must be disconnected.**



## 7 Installation

The unit may be mounted in a panel of any thickness up to a maximum of 3 mm. Leave enough space behind the instrument to allow for bends in the connection cables. The unit is intended for use in a reasonably stable ambient temperature within the range -25°C to +55°C. Do not mount the unit where there is excessive vibration or in excessive direct sunlight.



## 7.1 Safety

The unit is designed in accordance with IEC 61010-1:2010 – Permanently connected use, Normal condition. Installation category III, pollution degree 2, basic insulation for rated voltage.

## 7.2 EMC Installation Requirements

Whilst this unit complies with all relevant EU EMC (electro-magnetic compatibility) regulations, any additional precautions necessary to provide proper operation of this and adjacent equipment will be installation dependent and so the following can only be general guidance:

Avoid routing wiring to this unit alongside cables and products that are, or could be, a source of interference.

The auxiliary supply to the unit should not be subject to excessive interference. In some cases, a supply line filter may be required.

To protect the product against incorrect operation or permanent damage, surge transients must be controlled. It is good EMC practice to suppress transients and surges at the source. The unit has been designed to automatically recover from typical transients; however in extreme circumstances it may be necessary to temporarily disconnect the auxiliary supply for a period of greater than 10 seconds to restore correct operation.

Screened communication leads are recommended and may be required. These and other connecting leads may require the fitting of RF suppression components, such as ferrite absorbers, line filters etc., if RF fields cause problems.

It is good practice to install sensitive electronic instruments that are performing critical functions in EMC enclosures that protect against electrical interference causing a disturbance in function.

### Warning



- **During normal operation, voltages hazardous to life may be present at some of the terminals of this unit. Installation and servicing should be performed only by qualified, properly trained personnel abiding by local regulations. Ensure all supplies are de-energized before attempting connection or other procedures.**
- **Terminals should not be user accessible after installation and external installation provisions must be sufficient to prevent hazards under fault conditions.**
- **This unit is not intended to function as part of a system providing the sole means of fault protection - good engineering practice dictates that any critical function be protected by at least two independent and diverse means.**
- **The unit does not have internal fuses therefore external fuses must be used for protection and safety under fault conditions.**
- **Never open-circuit the secondary winding of an energized current transformer.**
- **This product should only be operated with CT secondary connections Earthed.**
- **If this equipment is used in a manner not specified by the manufacturer, protection provided by the equipment may be impaired.**

**Auxiliary circuits (communication & relay outputs) are separated from metering inputs and 110-400V auxiliary circuits by at least basic insulation. Such auxiliary circuit terminals are only suitable for connection to equipment which has no user accessible live parts. The insulation for such auxiliary circuits must be rated for the highest voltage connected to the instrument and suitable for single fault condition. The connection at the remote end of such auxiliary circuits should not be accessible in normal use. Depending on application, equipment connected to auxiliary circuits may vary widely.**

## 7.3 Dimensions

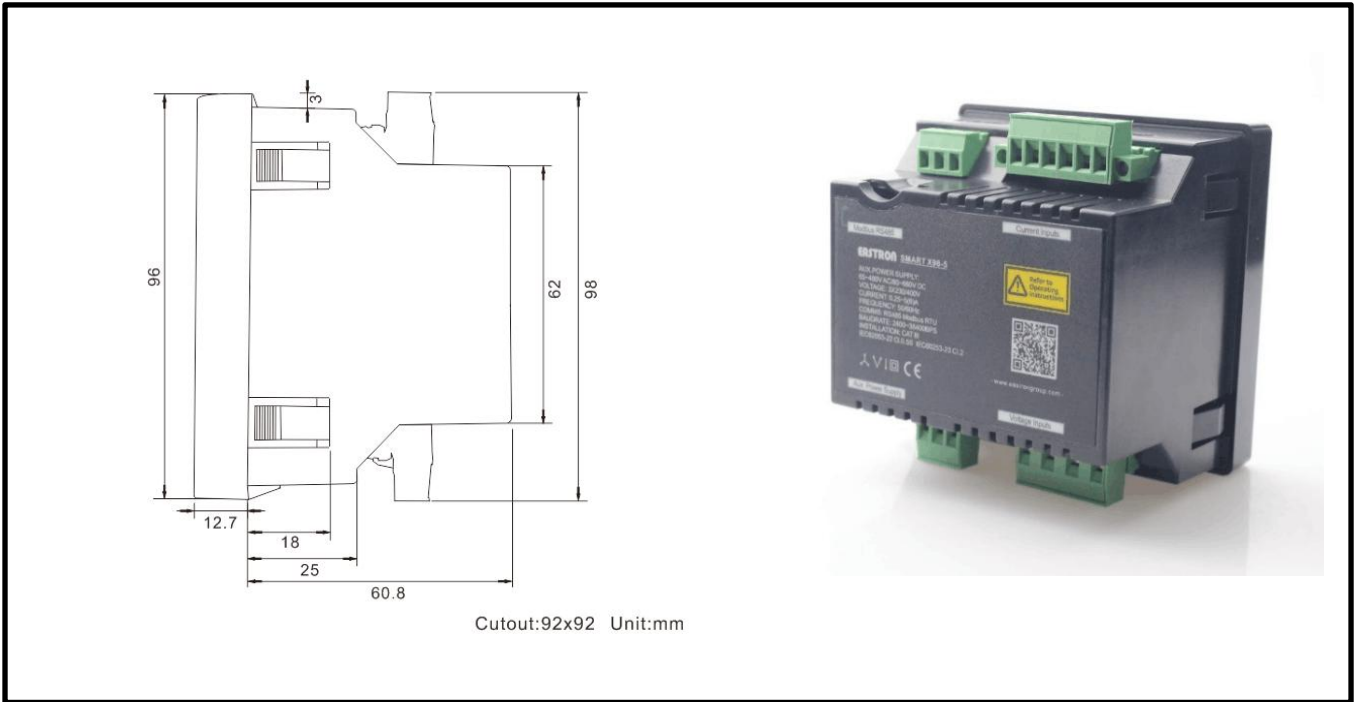

### 7.4 Mounting

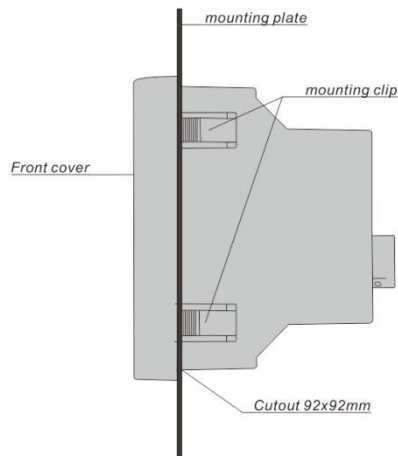

### 7.5 Wiring Diagram

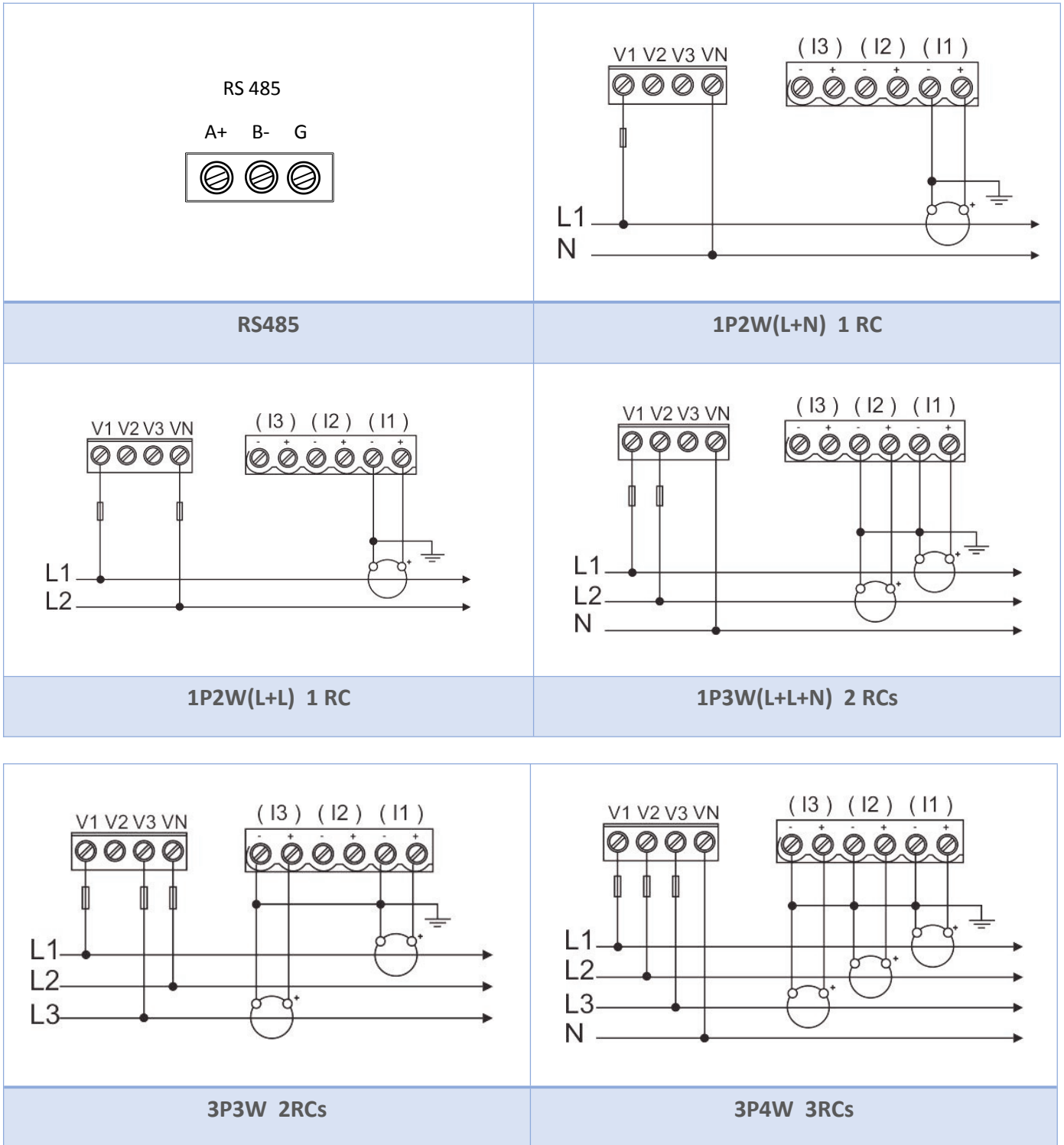

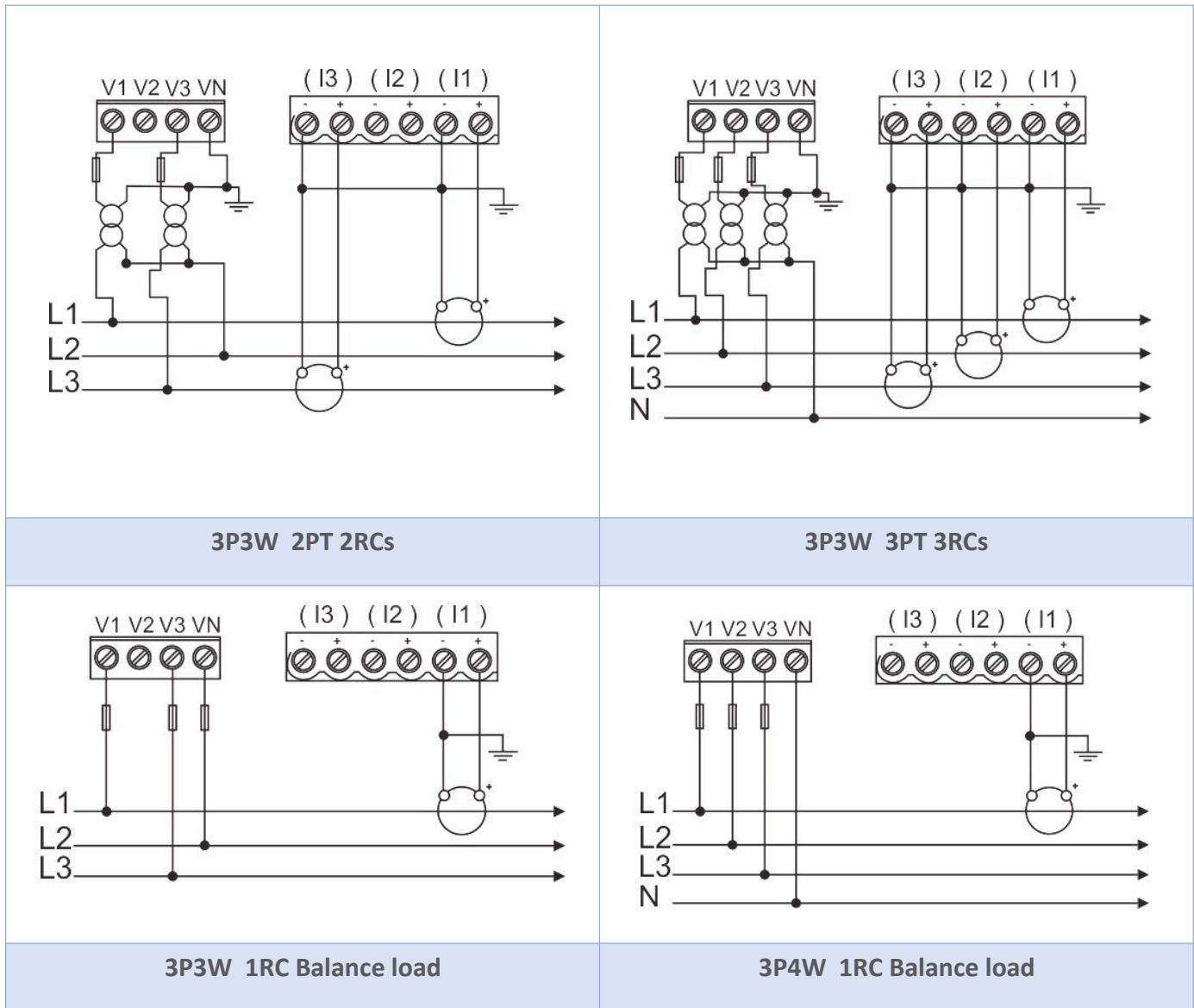

If you have any question, please feel free to contact our sales team.

Zhejiang Eastron Electronic Co.,Ltd.  
 No.1369,Chengnan Rd. Jiaxing, Zhejiang, 314001, China  
 Tel: +86-573-83698881 83698882  
 Fax: +86-573-83698883  
 Email: sales@eastrongroup.com  
[www.eastron.com.cn](http://www.eastron.com.cn)  
[www.eastrongroup.com](http://www.eastrongroup.com)