

generalità <i>generalities</i>	I - 2
codici per l'ordinazione <i>order references</i>	I - 3
dati tecnici <i>technical data</i>	I - 5
dimensionali <i>dimensions</i>	I - 7
accessori <i>accessories</i>	I - 10

Interruttori di manovra sezionatori
Switch disconnectors

16 ÷ 160 A

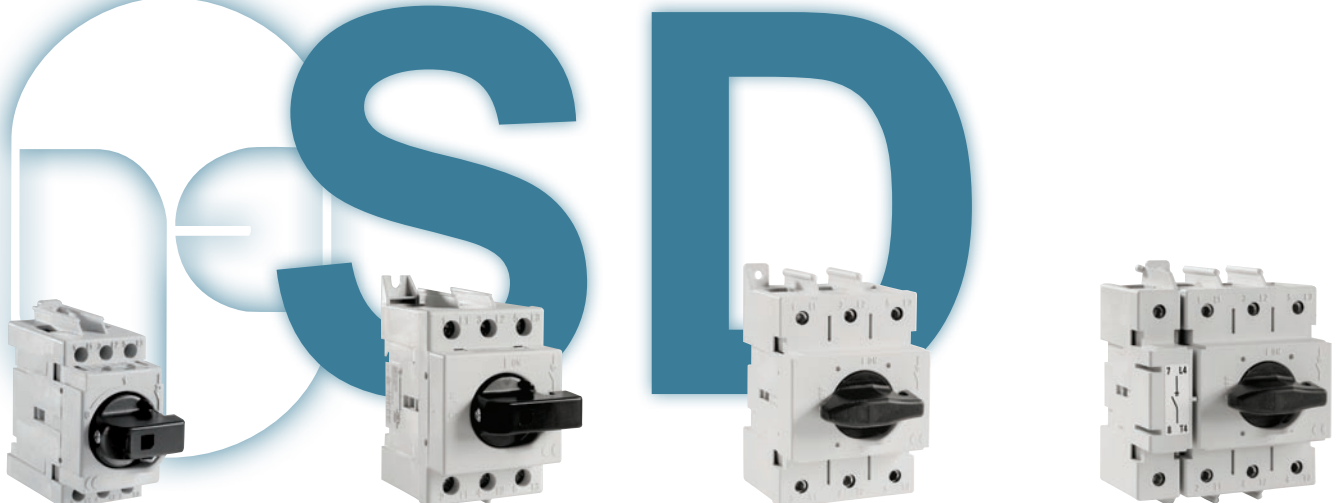

GENERALITA'

Gli **interuttori-sezionatori modulari della serie SD**, consentono l'interruzione e il sezionamento sotto carico di macchine e linee di bassa tensione con correnti nominali da 16 a 160 A.

IMPIEGO

Gli apparecchi della serie **SD** sono abitualmente impiegati nelle seguenti funzioni:

- > interruttore generale
- > interruttore per partenze motori
- > interruttore di sicurezza
- > sezionatore

CARATTERISTICHE GENERALI

- > alto potere d'interruzione (AC 22 A - AC 23 A)
- > doppia interruzione per ogni polo
- > elevata durata meccanica ed elettrica
- > adatto per l'utilizzo in climi tropicali
- > grado di protezione IP20 (accessori inclusi)
- > esecuzione modulare montaggio su profilato DIN 35 mm e a vite, finestra modulare 45 mm.

COMPOSIZIONE DELLA GAMMA

SD1 corpo tripolare con le portate da 16 - 25 - 32 - 40 - 63 A

SD2 corpo tripolare con le portate da 63 - 80 - 100 - 125 A

SD3 corpo tripolare con le portate da 125 - 160 A

POLI AGGIUNTIVI

Quarto polo sezionato, polo di neutro e di terra passanti.

COMANDO

Maniglia diretta nera (esecuzione standard), o di emergenza lucchettabile in posizione di zero.

Maniglia con e senza blocco porta, nera, o di emergenza, con possibilità di tre blocchi lucchettabili in posizione di zero.

Grado di protezione IP 65.

A levetta lucchettabile in posizione 0 (sezionatore SD2).

Vasta gamma di accessori.

CONFORMITA' ALLE NORME

IEC 60947/1-3

CEI EN 60947/1-3

UL508

CERTIFICATI E OMOLOGAZIONI

- > CESI
- > UL
- > TUV
- > INTEK
- > GOST R

GENERALITIES

The modular switch disconnectors of SD series, allow the breaking and the disconnecting on load of equipment on low voltage at nominal current from 16 to 160 A.

USE

The switch disconnectors of SD series are commonly used for the following purposes:

- > main switch
- > switch for motors
- > safety switch
- > disconnecter

GENERAL CHARACTERISTICS

- > high breaking capacity (AC 22 A - AC 23 A)
- > double break contacts
- > high electrical and mechanical endurance
- > resistant to damp heat
- > IP20 degree of protection (with accessory)
- > modular execution, basic mounting on 35 mm DIN rail and by screws, modular window 45mm.

RANGE COMPOSITION

SD1 three poles 16 - 25 - 32 - 40 - 63 A

SD2 three poles 63 - 80 - 100 - 125 A

SD3 three poles 125 - 160 A

ADDITIONAL POLES

Fourth switched pole, solid neutral and earth pole.

OPERATING MECHANISM

Black (standard execution) or emergency direct handle padlockable in 0 position.

Handle with and without door interlock handle, black or emergency handle padlockable with up to three padlocks in 0 position.

IP 65 degree of protection.

By toggle padlockable in 0 position (switch SD2). Wide range of accessories.

CONFORMITY TO STANDARDS

IEC 60947/1-3

CEI EN 60947/1-3

UL508

CERTIFICATES AND APPROVALS

- > CESI
- > UL
- > TUV
- > INTEK
- > GOST R

Codici per
l'ordinazione
Order references



Tipo Type	Corrente nominale Rated current	Maniglia diretta (nera) Direct handle (black)		Maniglia diretta emergenza Direct emergency handle	
		Poli / Poles	Codice / Code	Poli / Poles	Codice / Code
SD1	16A	3P	19300	3P	19310
		4P	19330	4P	19350
		6P	193006	6P	193106
	25A	8P	193308	8P	193508
		3P	19301	3P	19311
		4P	19331	4P	19351
	32A	6P	193016	6P	193116
		8P	193318	8P	193518
		3P	19302	3P	19312
	40A	4P	19332	4P	19352
		6P	193026	6P	193126
		8P	193328	8P	193528
	63A	3P	19303	3P	19313
		4P	19333	4P	19353
		6P	193036	6P	193136
SD1 retroportella door mounting switch discon- nector	16A	8P	193338	8P	193538
		3P	19304	3P	19314
		4P	19334	4P	19354
	25A	6P	193046	6P	193146
		8P	193348	8P	193548
		3P	19300R	3P	19310R
	32A	4P	19330R	4P	19350R
		3P	19301R	3P	19311R
	40A	4P	19331R	4P	19351R
		3P	19302R	3P	19312R
	63A	4P	19332R	4P	19352R
		3P	19303R	3P	19313R
		4P	19333R	4P	19353R
		3P	19304R	3P	19314R
			4P	19334R	4P



SD2	63A	3P	19205	3P	19215	
		4P	19235	4P	19255	
		6P	192056	6P	192156	
	80A	8P	192358	8P	192558	
		3P	19206	3P	19216	
		4P	19236	4P	19256	
	100A	6P	192066	6P	192166	
		8P	192368	8P	192568	
		3P	19207	3P	19217	
	125A	4P	19237	4P	19257	
		6P	192076	6P	192176	
		8P	192378	8P	192578	
	SD2 levetta toggle	63A	3P	19208	3P	19218
			4P	19238	4P	19258
			6P	192086	6P	192186
80A		8P	192388	8P	192588	
		3P	19205LE	-	-	
		4P	19235LE	-	-	
100A	3P	19206LE	-	-		
	4P	19236LE	-	-		
	3P	19207LE	-	-		
125A	4P	19237LE	-	-		
	3P	19208LE	-	-		
		4P	19238LE	-	-	



SD3	125A	3P	19701	3P	19711
		4P	19731	4P	19751
	160A	3P	19702	3P	19712
		4P	19732	4P	19752

Dati tecnici gamma standard
Technical data range standard

CEI/EN 60947/1-3
IEC 60947/1-3

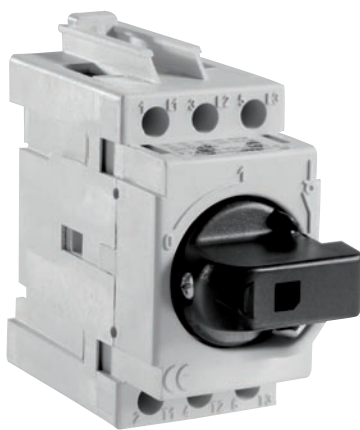

Caratteristiche Characteristics		16A	25A	SD1			SD2				SD3	
Tensione nominale d'isolamento Rated insulation voltage	Ui (V)	800	800	800	800	800	800	800	800	800	800	800
Tensione nominale tenuta impulso Impulse withstand voltage	Uimp (kV)	8	8	8	8	8	8	8	8	8	8	8
Corrente nominale termica a 40°C Rated thermal current at 40°C	Ith/Ithe (A)	16	25	32	40	63	63	80	100	125	125	160
Corrente nominale d' impiego Ie / Rated operational current Ie												
AC-21A	415V (A)	16	25	32	40	63	63	80	100	125	125	160
	500V (A)	16	25	32	40	63	63	80	100	125	125	160
	690V (A)	16	25	32	40	63	63	80	100	125	125	160
AC-22A	415V (A)	16	25	32	40	63	63	80	100	125	125	160
	500V (A)	16	25	32	40	63	63	80	100	100	125	160
	690V (A)	16	25	32	40	40	40	40	40	40	125	160
AC-23A	415V (A)	16	25	32	40	40	63	80	100	100	125	160
	500V (A)	16	25	32	40	40	63	63	63	63	125	125
	690V (A)	16	25	25	25	25	32	32	32	32	100	100
Potere di chiusura a 415V AC23 Rated making capacity at 415V AC23	(A)	160	250	320	400	400	630	800	1000	1000	1250	1600
Potere di interruzione a 415V AC23 Rated breaking capacity at 415V AC23	(A)	128	200	256	320	320	504	640	800	800	1000	1280
Potenza nominale di impiego AC23 Rated operational power AC23	415V (kW)	7.5	11	14	15	15	29	37	46	46	55	69
	500V (kW)	7.5	11	14	15	18.5	35	35	35	35	65	83
	690V (kW)	7.5	11	14	15	18.5	24	24	24	24	90	90
Corrente di breve durata per 1 sec Short-circuit withstand current 1 sec	(400V) (kA)	1.1	1.1	1.1	1.1	1.1	1.5	1.5	1.5	1.5	3	3
Corrente di corto circuito condizionata da fusibile / Rated fuse short circuit current												
Tipo fusibile gG / Back up fuse gG	(A)	16	25	32	40	63	63	80	100	125	125	125
Valore efficace / R.M.S. value	(kA)	50	50	50	50	20	50	50	30	20	50	50
Valore di picco / Peak value	(kA)	3.8	4.5	5	5.7	5.7	8	9.9	9.9	9.9	10.5	10.5
Durata meccanica Mechanical endurance	n.	50000	50000	50000	50000	50000	30000	30000	30000	30000	30000	30000
Durata elettrica / Electrical endurance	n.	3000	3000	3000	3000	3000	3000	1500	1500	1000	1000	1000
Potenza dissipata per polo Power loss per pole	W	0.1	0.1	0.2 30	0.3	0.8	0.8	1.3	2.0	3.1	2.5	3
Dimensione cavo / Cable section	mmq	16	16	16	16	16-25	*16-50	*16-50	25-50	35-50	10÷70	10÷70
Max. torsione terminali Max terminal torque	Nm	2	2	2	2	2	2,5	2,5	2,5	2,5	6	6
Sforzi di manovra / Operation torque	Nm	1.6	1.6	1.6	1.6	1.6	1.6	1.6	1.6	1.6	2,6	2,6
Contatti ausiliari AC 15/415V Auxiliary contacts AC 15/415V	A	3	3	3	3	3	3	3	3	3	3	3
Peso netto 3 poli / Net weight 3 poles	Kg.	0.13	0.13	0.13	0.13	0.13	0.25	0.25	0.25	0.25	0,4	0,4
Peso netto 4 poli / Net weight 4 poles	Kg.	0.16	0.16	0.16	0.16	0.16	0.32	0.32	0.32	0.32	0,5	0,5
Peso netto 6 poli / Net weight 6 poles	Kg.	0.30	0.30	0.30	0.30	0.30	0.55	0.55	0.55	0.55	-	-
Peso netto 8 poli / Net weight 8 poles	Kg.	0.40	0.40	0.40	0.40	0.40	0.62	0.62	0.62	0.62	-	-

* Con terminale aggiunto / With added terminal

Dati tecnici gamma standard
 Technical data range standard

UL 508



Caratteristiche / Characteristics		SD1			SD2			SD3				
Corrente generale / Rating 3 poles		16A	25A	32A	40A	63A	80A	100A	125A	100A	125A	160A
Uso generale / General use	(V AC)	600	600	600	600	600	600	600	600	600	600	600
Valore di corto circuito / Short circuit rating	(kA)	5	5	5	5	5	5	5	5	10	10	10
Tipo fusibile / Fuse type		RK5	RK5	RK5	RK5	RK5	RK5	RK5	RK5	RK5	RK5	RK5
Valore fusibile / Fuse rating	(A)	40	40	40	40	125	125	125	125	175	175	175
Max. potenza impiego UL 3 fasi Maximum UL horsepower 3 phases	120V (Hp)	3	3	3	3	5	5	5	5	15	20	20
	240V (Hp)	5	7.5	7.5	10	10	15	15	15	30	40	40
	415V (Hp)	7.5	10	10	15	20	25	25	25	50	60	60
	480V (Hp)	10	15	20	20	25	30	30	30	75	100	100
	600V (Hp)	15	20	25	30	30	40	40	40	100	125	125
Max. potenza impiego UL 1 fase Maximum UL horsepower 1 phase	120V (Hp)	-	-	-	-	3	5	5	5	-	-	-
	240V (Hp)	-	-	-	-	7.5	10	10	10	-	-	-
Max. carico avviamento motore 3 fasi Maximum full load motor running 3 phases	120V (A)	19,2	19,2	19,2	19,2	30,4	30,4	30,4	30,4	84	108	108
	240V (A)	15,2	22	22	28	42	42	42	42	80	104	104
	415V (A)	14	18	18	27	44	44	44	44	83	103	103
	480V (A)	14	21	27	27	40	40	40	40	84	104	104
	600V (A)	17	22	27	32	41	41	41	41	99	125	125
Max. carico avviamento motore 1 fase Maximum full load motor running 1 phase	120V (A)	-	-	-	-	56	56	56	56	-	-	-
	240V (A)	-	-	-	-	50	50	50	50	-	-	-
Durata meccanica / Mechanical endurance	n.	6000	6000	6000	6000	6000	6000	6000	6000	6000	6000	6000
Durata elettrica / Electrical endurance	n.	6000	6000	6000	6000	6000	6000	6000	6000	6000	6000	6000
Sezione terminali / Wire size range	AWG	16÷6	16÷6	16÷6	16÷6	6÷1	6÷1	6÷1	6÷1	3/0÷6	3/0÷6	3/0÷6
Tipo terminale / Tightening type		Cu	Cu	Cu	Cu	Cu	Cu	Cu	Cu	Cu	Cu	Cu
Max. torsione terminali / Max terminal Torque	Nm	2	2	2	2	3.5	3.5	3.5	3.5	6	6	6
Peso netto / Net weight	Kg.	0.13	0.13	0.13	0.13	0.25	0.25	0.25	0.25	0.25	0.25	0.25

Dimensioni
Dimensions



L
L = 10 mm

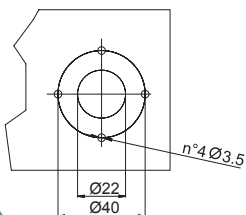

SD1 3 - 4 poli / poles

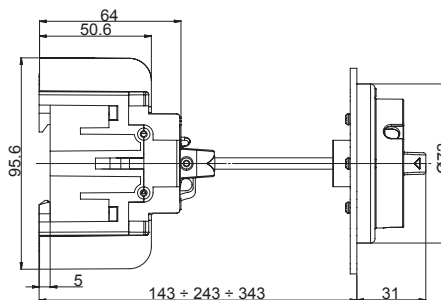
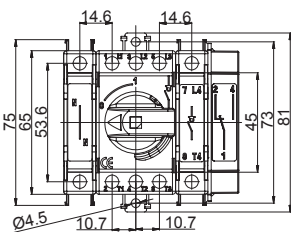
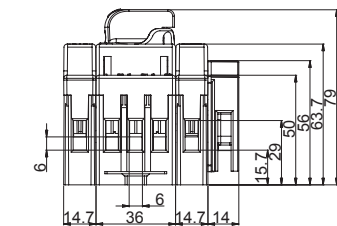

L
L = 10 mm

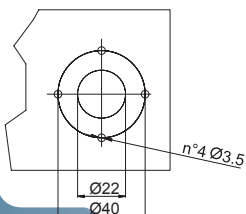

SD1 6 - 8 poli / poles

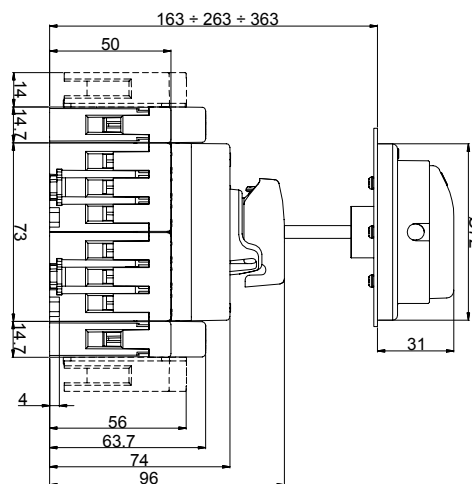
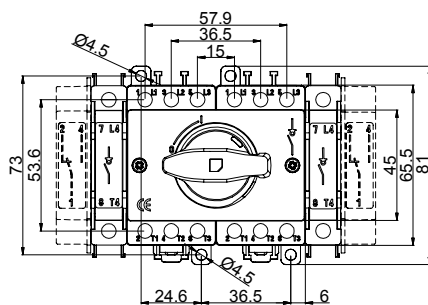

L
L = 10 mm

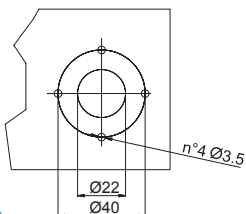

SD1 retroportella / door mounting switch disconnecter

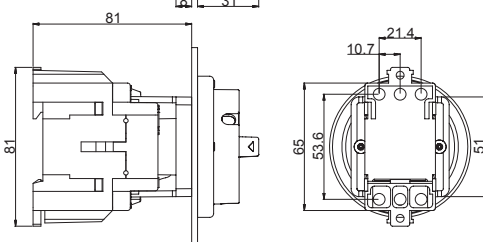
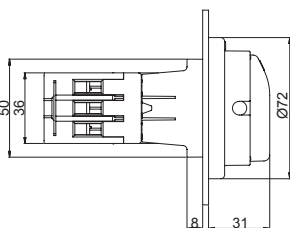

Dimensioni
Dimensions

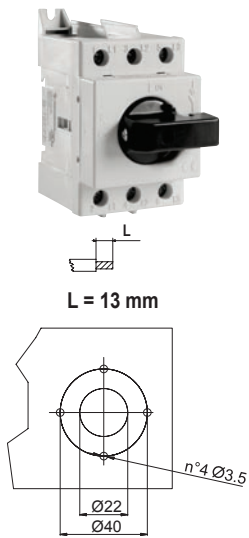

SD2 3 - 4 poli / poles

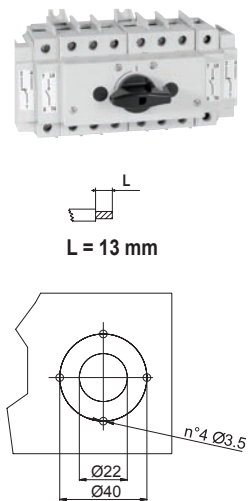
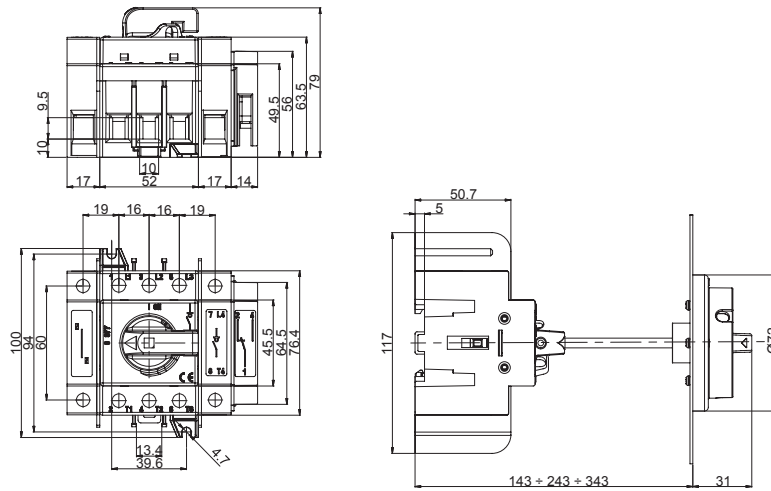

SD2 6 - 8 poli / poles

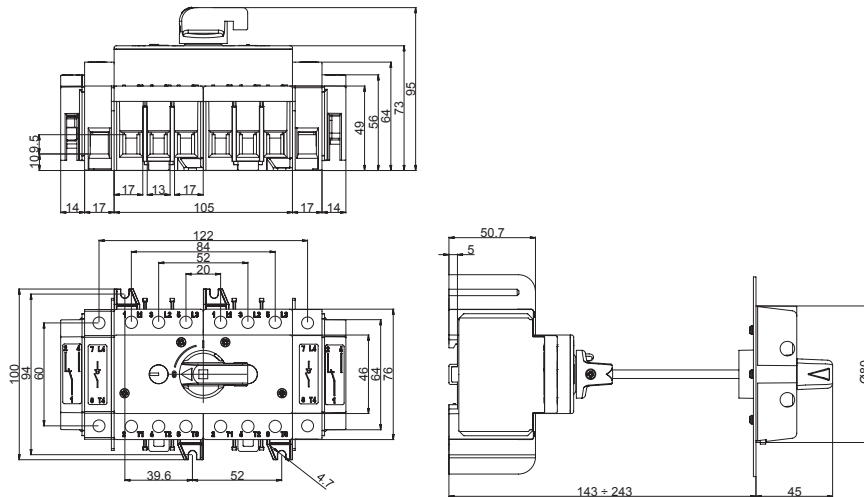

SD2 levetta / toggle

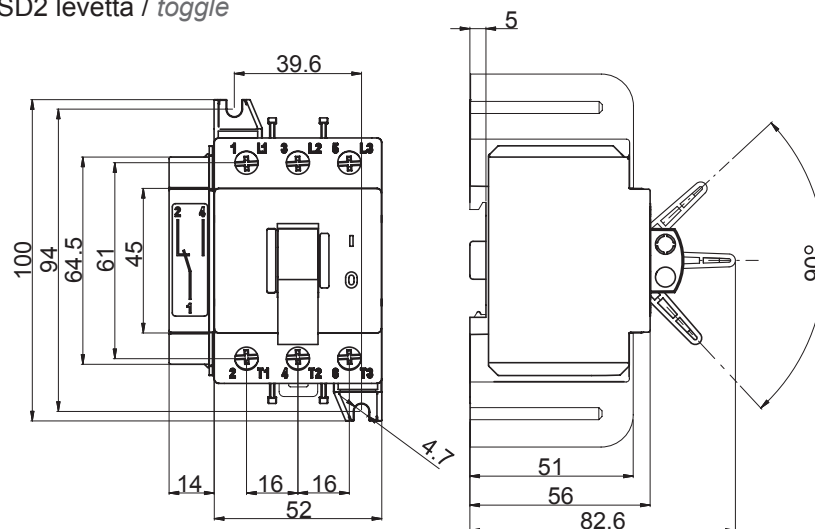

Dimensioni
Dimensions



L = 15 mm

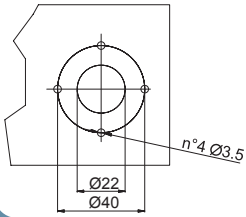

SD3

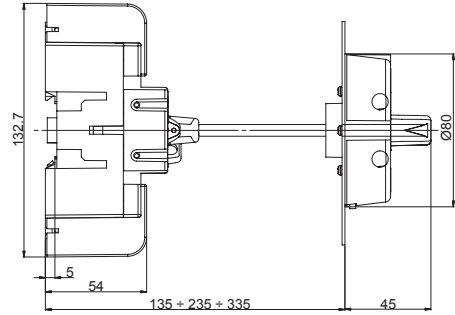
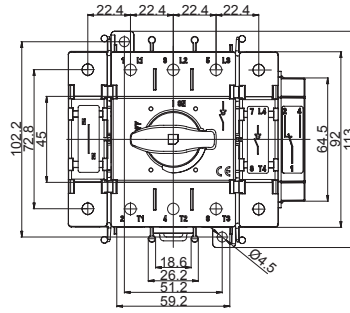
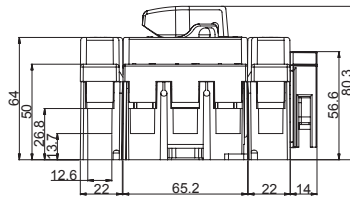

Accessori
Accessories

Codici per
l'ordinazione
Order references

maniglia blocco porta
door interlock handle

Tipo / Type	SD1 - SD2 rotonda nera / black round	SD1 - SD2 rotonda giallo-rossa / yellow-red round
Codice / Code	19400	19401



19400



19401



maniglia blocco porta
door interlock handle

Tipo / Type	SD1 - SD2 - SD3 quadrata nera / black square	SD1-SD2-SD3 quadrata giallo-rossa / yellow-red square
Codice / Code	19403	19404



19403



19404

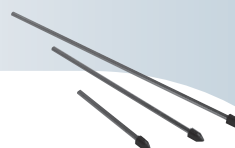

maniglia blocco porta con
sblocco
door interlock handle with
defeater mechanism

Tipo / Type	SD1 - SD2 - SD3 nera / black	SD1-SD2-SD3 giallo-rossa / yellow-red
Codice / Code	19406	19407



19406

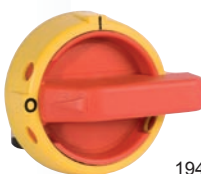

19407



maniglia blocco porta con
ghiera
door interlock handle with
ring

Tipo / Type	SD1 - SD2 rotonda nera / black round	SD1 - SD2 rotonda giallo-rossa / yellow-red round
Codice / Code	19460	19461



19460



19461



maniglia blocco porta
door interlock handle

Tipo / Type	SD1 - SD2 - SD3 quadrata nera / black square	SD1-SD2-SD3 quadrata giallo-rossa / yellow-red square
Codice / Code	19463	19464



19463



19464



maniglia blocco porta con
sblocco con ghiera
door interlock handle with
defeater mechanism with
ring

Tipo / Type	SD1 - SD2 - SD3 nera / black	SD1-SD2-SD3 giallo-rossa / yellow-red
Codice / Code	19466	19467



19466

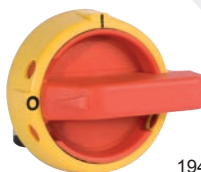

19467



Accessori
Accessories

Codici per
l'ordinazione
Order references

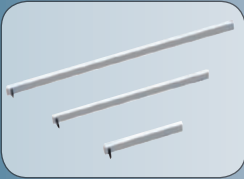

alberi di comando / shaft

Tipo/Type	SD1 - SD2 alluminio / aluminum		SD1 - SD2 acciaio / steel		
mm	100	200	100	200	300
Codice Code	19535-100	19535-200	19534-100	19534-200	19534-300

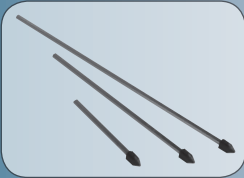

alberi di comando con puntale / shaft with point

Tipo/Type	SD1 - SD2 alluminio / aluminum		SD1 - SD2 - SD3 acciaio / steel		
mm	100	200	100	200	300
Codice Code	19535-100P	19535-200P	19534-100P	19534-200P	19534-300P



4° polo / 4th pole

Tipo Type	SD1	SD2	SD3
Codice Code	19442	19443	19444



neutro / neutral

Tipo Type	SD1	SD2	SD3
Codice Code	19320	19418	19450



morsetto di terra / earthing neutral

Tipo Type	SD1	SD2	SD3
Codice Code	19322	19422	19452



neutro passante / solid neutral

Tipo Type	SD1	SD2	SD3
Codice Code	19321	19420	19451

Accessori
Accessories

Codici per
l'ordinazione
Order references



contatti ausiliari 1NA+1NC terminali a vite
auxiliary contacts 1NO+1NC screw terminals

Tipo Type	SD1	SD2	SD3
Codice Code	19429	19429	19429

Portata nominale 10A 400V - 16A 250V ca
Apertura anticipata rispetto all'apertura dei contatti principali dell'interruttore.
Rated current 10A 400V - 16A 250V ac - Break before main contacts.



contatti ausiliari 1NA+1NC terminali a Faston
auxiliary contacts 1NO+1NC Faston terminals

Tipo Type	SD1	SD2	SD3
Codice Code	19430	19430	19430

Portata nominale 10A 400V - 16A 250V ca
Apertura anticipata rispetto all'apertura dei contatti principali dell'interruttore.
Rated current 10A 400V - 16A 250V ac - Break before main contacts.



kit compriterminali 3 poli / 3 poles terminals cover kit

Tipo Type	SD1	SD2	SD3
Codice Code	19424	19425	19453



kit compriterminali 4° polo / 4th pole terminals cover kit

Tipo Type	SD1	SD2	SD3
Codice Code	19426	19427	19454

